

110A Series "APCO" One & Two Stage Turbine Type Pumps

- Capacities To 150 GPM
- Heads To 700 Feet
- Temperatures To 275° F

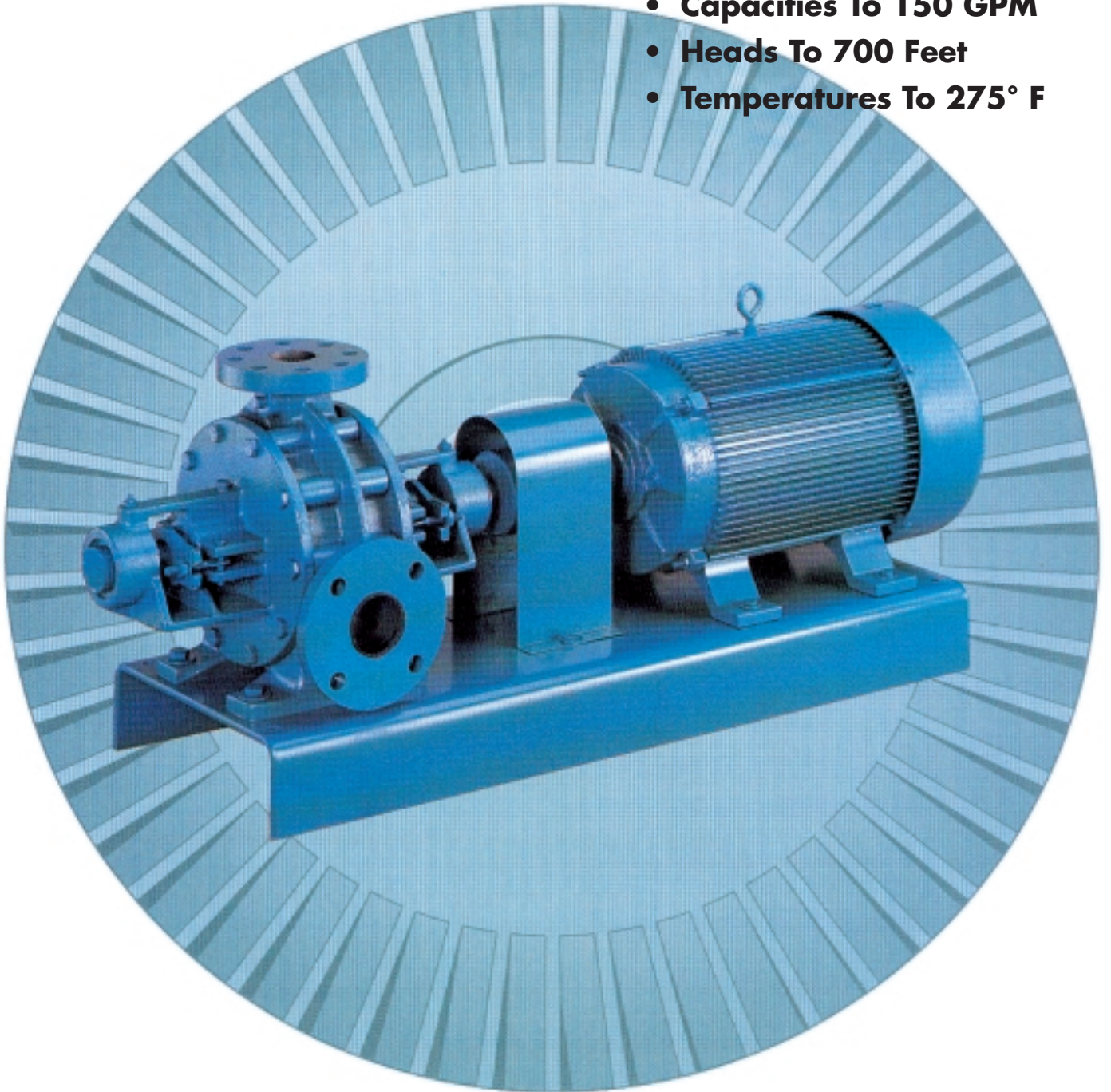

110A Series Pumps

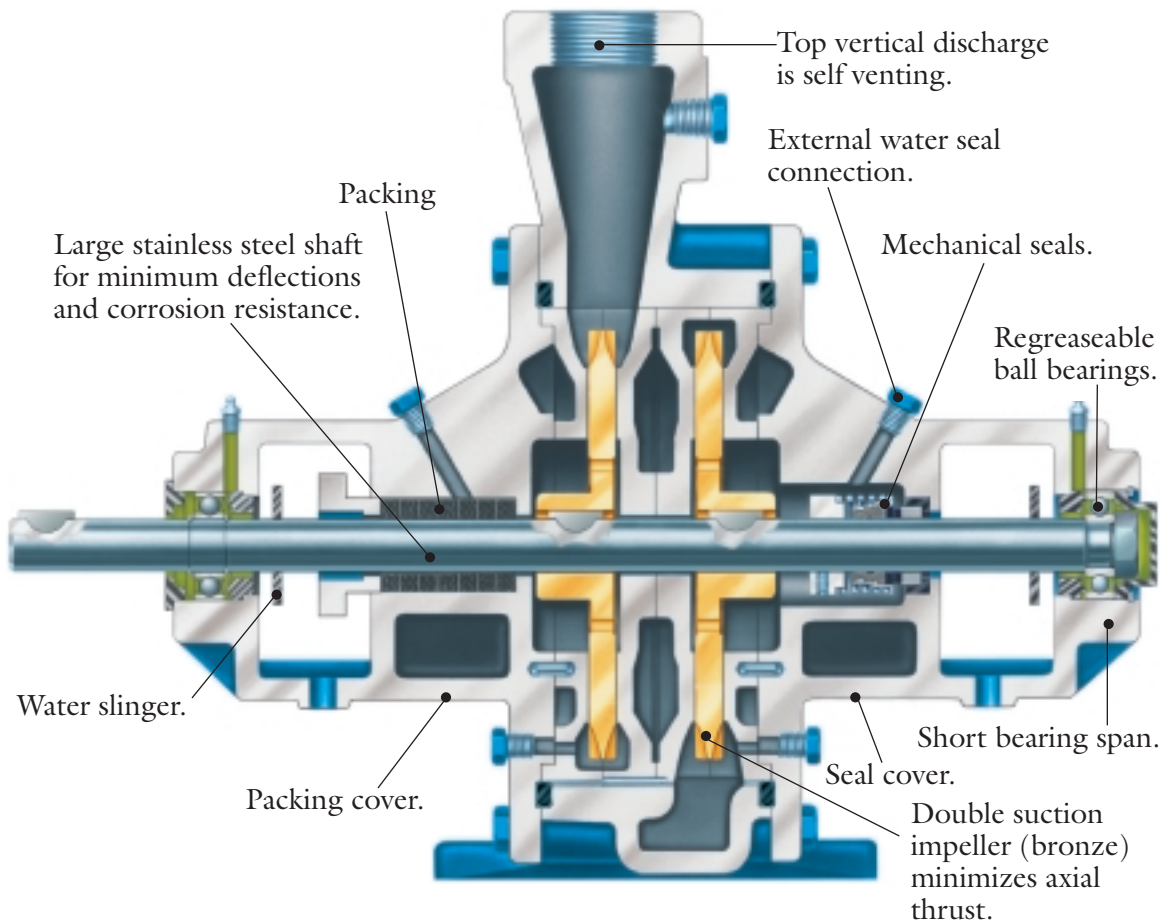

Typical Two-Stage Unit Shown

Applications

- Boiler Feed
- Condensate Return
- Cooling Systems
- High Pressure Spray
- Booster Systems
- Jockey Pumps
- Chlorine Injection
- Chemical Feed Systems
- Laundry and Dry Cleaning Systems
- Laser Cooling
- Electrostatic Discharge Machines
- TV Tube and CRT Manufacturing
- Car Washes

Benefits

- Reliability
- Years of Field-proven Service
- Reduce Energy Consumption
- Trouble-free Operation
- High Performance
- Save Space
- Versatility
- Complete Technical Support
- Low Flow/High Head Capabilities

Introduction

Apco regenerative turbine pumps are field-proven throughout the world. Apco pumps are ideal for handling: (1) high head/low flow requirements, (2) liquids entrained with gases and vapors (up to 20%), and (3) constant flows.

You are assured of reliable pumping service because every Apco is tested to insure consistent performance.

Apco pumps are designed for those special applications where high head and low flow are required by the system. Boiler feed systems, for example, require high pressure to get low flows of water into the pressurized steam boiler.

Conventional centrifugal pumps, in contrast, must operate close to shut off or operate at high speed to meet these high head/low flow requirements. These mis-applications can cause high vibration, mechanical damage, frequent maintenance, and excessive energy use.

Apco pumps thrive in high head/low flow applications so you save on operating costs (less maintenance, downtime and energy costs).

Increase System Reliability with Constant Flow

Apco pumps assure constant flow when you need it. The steep performance curve allows for minimal changes in the capacity even with large pressure variations.

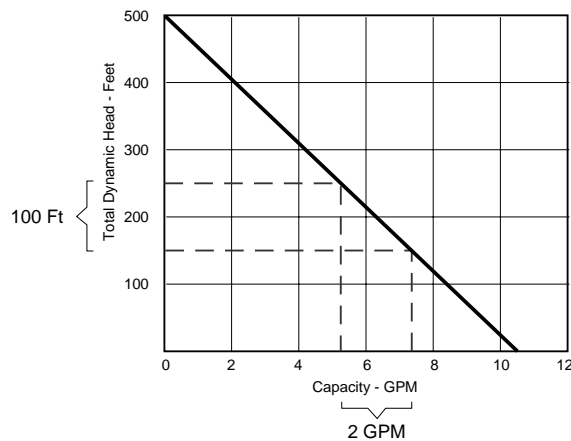

The curve above shows that with a 100 foot change in head, the capacity varies only 2 gallons per minute. You get a virtually constant flow over wide pressure variations to ensure reliable system operation.

The constant flow characteristics make the Apco ideal for cooling systems where it is vital that sufficient flow is maintained to dissipate heat despite changes in pressure.

Pressure variations occur for a number of reasons. The most common designed-in variations are caused by automatic pop-off valves and similar control devices.

With Apco pumps, you can always depend on the same capacity despite variations in head pressure and achieve increased system reliability.

Standard

- Bronze fitted construction
- Hydraulically balanced bronze impeller
- Right or left hand rotation
- Regreaseable ball bearings
- Short bearing span
- Mechanical seals or graphite impregnated acrylic packing
- 416 hardened stainless steel shaft
- Floating impellers
- Removable channel rings
- VIP Test – Every pump is given a hydrostatic test at 1-1/2 times rated pressure along with a running test for head and capacity performance check.

Optional

- All iron, bronze ring or all bronze construction
- 316 stainless steel or monel shaft
- External sealing line to stuffing box
- Lantern ring (5 & 6 series 110)
- Formed steel or drip-rim bases
- Bypass with manual shut-off valves
- Bypass with relief valve
- Self-priming features
- Certified performance test data can be supplied consisting of head, capacity and horsepower readings taken over the full operating range of the pump.

Selection Charts

1750 R.P.M.

CAPACITY GPM	TOTAL DYNAMIC HEAD IN FEET																							
	10	20	30	40	50	60	70	80	100	115	130	145	160	180	200	220	240	260	280	300	350	400	450	500
2	B4 1/2	B4 1/2	A35 1/2	A35 1/2	A35 1/2	A4 1/2	A4 1/2	A4 1/2	C4 1/2	D4 1/2	D4 1/2	D4 1/2	D4 1/2	D4 3/4	D4 1	D5 1	D5 1	D5 1	D4T 1	D4T 1 1/2	D4T 1 1/2	E4T 1 1/2	G4T 3	D5T 3
5	C4 1/2	C4 1/2	D4 1/2	D4 1/2	D4 1/2	D4 1/2	D4 1/2	D4 1/2	D4 1/2	E4 1 1/2	F4 1	F4 1	F4 1	F4 1	G4 1	G4 1 1/2	G4 1 1/2	F4T 1 1/2	F4T 2	F4T 2	G4T 2	G4T 3	G4T 3	G5T 5
10	F4 1/2	F4 1/2	F4 1/2	F4 1/2	F4 1/2	G4 3/4	G4 3/4	G4 3/4	G4 1	G4 1	G4 1	G4 1	I4 1 1/2	I4 1 1/2	G4T 1 1/2	G4T 2	G4T 2	I4T 2	I4T 3	H5 3	H5 5	G5T 5	G5T 5	H5T 5
15	G4 1/2	G4 1/2	G4 1/2	H4 3/4	H4 3/4	H4 1	H4 1	H4 1	I4 1	I4A 1 1/2	I4A 2	I4A 2	I4T 2	I4T 2	I4TA 2	I4TA 3	I4TA 3	I4TA 3	I5 5	I5 5	I5 5	H5T 5	H5T 5	I5T 7 1/2
20	H4 3/4	H4 3/4	H4 3/4	H4 3/4	H4 3/4	I4 1	I4A 1 1/2	I4A 1 1/2	I4A 1 1/2	I4A 1 1/2	I4TA 2	I4TA 3	I4TA 3	I4TA 3	I4TA 3	I5 5	I5 5	I5 5	I5 5	I5 5	L5 7 1/2	I5T 7 1/2	D6T 10	D6T 10
25	I4A 3/4	I4A 3/4	I4A 3/4	I4A 1	I4A 1	M4 1 1/2	M4 1 1/2	M4 1 1/2	M4 2	M4 2	R4 3	I5 3	I5 3	I5 3	J5 5	J5 5	K5 7 1/2	L5 7 1/2	L5 10	L5 10	L5 10	I5T 7 1/2	D6T 10	E6T 15
30	I4A 3/4	I4A 3/4	M4 1	M4 1	M4 1	M4 1 1/2	M4 1 1/2	M4 1 1/2	P4 3	R4 3	J5 5	J5 5	J5 5	K5 5	K5 5	L5 7 1/2	L5 7 1/2	L5 7 1/2	L5 10	L5 10	E6T 10	E6T 15	E6T 15	E6T 15
35	M4 3/4	M4 3/4	M4 1	M4 1	M4 1 1/2	M4 1 1/2	P4 2	P4 2	P4 3	R4 3	K5 5	K5 5	L5 5	L5 5	L5 7 1/2	L5 7 1/2	L5 7 1/2	L5 10	G6 10	G6 10	E6T 10	E6T 15	F6T 15	G6T 20
40	M4 1/2	M4 3/4	M4 1	M4 1	P4 1 1/2	P4 2	P4 2	P4 2	R4 3	L5 5	L5 5	L5 5	L5 7 1/2	L5 7 1/2	L5 7 1/2	L5 10	G6 10	G6 10	G6 10	E6T 10	F6T 15	F6T 15	G6T 20	G6T 20
50	P4 1	P4 1 1/2	P4 1 1/2	P4 1 1/2	R4 2	R4 3	R4 3	L5 3	L5 5	L5 5	L5 5	L5 5	L5 5	P5 10	P5 10	H6 10	F6T 10	F6T 10	F6T 10	G6T 10	G6T 15	G6T 15	G6T 20	
60	R4 1 1/2	R4 1 1/2	R4 1 1/2	R4 2	L5 3	L5 3	L5 3	L5 5	L5 5	P5 7 1/2	P5 7 1/2	P5 10	P5 10	P5 10	P5 10	H6 10	J6 15	G6T 15	G6T 15	G6T 15	G6T 15	J6T 25	J6T 25	
70	L5 2	L5 3	L5 3	L5 3	L5 3	N5 3	N5 3	N5 5	P5 7 1/2	P5 7 1/2	P5 10	P5 10	P5 10	H6 10	J6 15	J6 15	G6T 15	G6T 15	H6T 15	H6T 15	J6T 20	J6T 25	K6T 30	
80	M5 1 1/2	M5 1 1/2	N5 2	N5 3	N5 3	N5 3	P5 5	P5 7 1/2	P5 7 1/2	P5 7 1/2	P5 10	P5 10	H6 10	J6 10	J6 15	H6T 15	H6T 15	H6T 15	H6T 15	J6T 20	J6T 20	K6T 25		
90	N5 2	N5 2	N5 2	P5 5	P5 5	P5 5	P5 5	P5 7 1/2	P5 7 1/2	P5 7 1/2	P5 10	J6 10	J6 10	J6 10	K6 15	H6T 15	H6T 15	J6T 20	J6T 20	J6T 20	K6T 25	K6T 25		
100	N5 2	P5 5	P5 5	P5 5	P5 5	P5 5	P5 7 1/2	P5 7 1/2	P5 7 1/2	J6 10	J6 10	J6 10	J6 10	K6 15	J6T 15	J6T 15	J6T 20	J6T 20	J6T 20	J6T 20	K6T 25			
120	P5 5	P5 5	P5 5	P5 5	P5 5	J6 7 1/2	J6 7 1/2	J6 7 1/2	J6 10	K6 10	K6 10	K6 10	J6T 15	J6T 15	J6T 15	J6T 15	K6T 20	K6T 20	K6T 20					
150	J6 5	J6 5	J6 5	J6 5	J6 5	K6 7 1/2	K6 7 1/2	K6 7 1/2	K6T 10	K6T 15	K6T 15													

DESIGN DETAILS

AREA	DIMENSIONS	110-SERIES PUMP MODEL				
		A35- I4A	M4- R4	D5- I5	J5- P5	G6- K6
		D4T- I4TA		D5T- I5T		D6T- K6T
STUFFING BOX	PACKING RINGS PER BOX	4	5	7	7	8
	PACKING SIZE (SQUARE)	1/4"	9/32"	1/4"	1/4"	5/16"
SHAFT	OUTSIDE DIA. OF SHAFT	.590	.787	.787	.984	1.181
BALL BEARINGS	INBOARD RADIAL	202	204	204	205	206
	OUTBOARD THRUST	300K	303K	303K	304K	305K

3500 R.P.M.

CAPACITY GPM	TOTAL DYNAMIC HEAD IN FEET								
	50	100	150	200	250	300	350	400	450
2	B4 1/2	B4 1/2	B4 3/4	B4 3/4	A35 1	A35 1	A4 1 1/2	A4 1 1/2	A4 2
4	B4 1/2	A35 3/4	A35 3/4	A35 1	A4 1	A4 1 1/2	D4 3	D4 5	D4 5
6	A35 1/2	A4 3/4	A4 3/4	C4 1 1/2	D4 3	D4 3	D4 3	D4 5	D4 5
8	C4 3/4	C4 3/4	C4 1	D4 3	D4 3	D4 3	D4 3	D4 5	D4 5
10	C4 3/4	D4 2	D4 2	D4 3	D4 3	D4 3			
12	D4 1 1/2	D4 2	D4 2	D4 3	D4 3				
14	D4 1 1/2	D4 2							
15	D4 1 1/2	D4 2							

Dimensions

Type 4 & 5 Series

4R, 4RA, 5R, 5RA

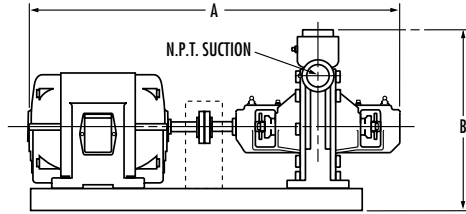

4R, 4RA, 5R, 5RA

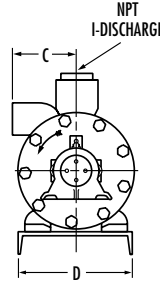

4RTL, 5RTL

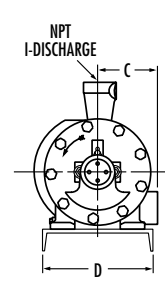

Type 6 Series

6RA, 6RTL, 6RATL

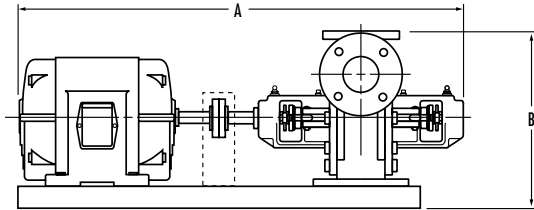

6RA

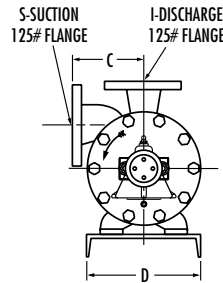

6RTL, 6RATL

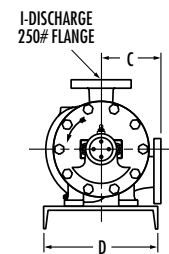

- Dimensions and weights are approximate.
- Dimensions are in inches and may vary $\pm 1/8"$.
- Not for construction purposes unless certified.
- Frame sizes shown are for open dripproof motors only.
- Conduit box is shown in approximate position. Dimensions are not specified as they vary with each motor manufacturer.
- All flanges are standard flat face.

- NOTES:
- Selections indicate pump size in upper portion and motor H.P. in lower portion of each block.
 - A35, A4, B4, C4 and D4 pumps are also available for 3500 R.P.M. operation. See table on page 4.
 - Maximum suction pressure is based on suction flange pressure rating.
 - All limitations are based on standard pumps constructed of standard materials and handling water.

SINGLE STAGE											TWO STAGE							
4R	A35, A4, B4, C4, D4, E4 F4, G4, H4, I4, I4A				4RA	M4, P4, R4				NEMA Motor Frame	1750 R.P.M. H.P.	4RTL	D4T, E4T, F4T, G4T, I4T, I4TA					
	Disch. 1 1/4		Suct. 1 1/4			Disch. 1 1/2		Suct. 1 1/2					Disch. 1 1/4		Suct. 1 1/4			
Unit Wgt.	A	B	C	D	Unit Wgt.	A	B	C	D			A	B	C	D			
86	24	12	4	7	125	27	11	4	9	56	1/2-3/4	125	25	11	4 1/2	9		
66	22	13	4	7	108	25	12	4	9	143T	1	105	23	12	4 1/2	9		
71	23	13	4	7	113	26	12	4	9	145T	1 1/2-2	110	24	12	4 1/2	9		
95	24	13	4	9	126	27	12	4	10	182T	3	126	25	13	4 1/2	10		
100	25	13	4	9	131	28	13	4	10	184T	5	131	26	13	4 1/2	10		
161	27	14	4	10	195	30	14	4	12	213T	7 1/2	195	28	14	4 1/2	12		
181	29	14	4	10	215	32	14	4	12	215T	10	215	30	14	4 1/2	12		
5R	D5, E5, F5, G5, H5, I5				5RA	J5, K5, L5, M5, N5, P5				NEMA Motor Frame	1750 R.P.M. H.P.	5RTL	D5T, E5T, F5T, G5T, H5T, I5T					
	Disch. 1 1/4		Suct. 1 1/4			Disch. 1 1/2		Suct. 2					Disch. 1 1/4		Suct. 1 1/4			
Unit Wgt.	A	B	C	D	Unit Wgt.	A	B	C	D			A	B	C	D			
125	28	15	5	9						56	1/2-3/4							
111	26	15	5	10	128	28	15	5	10	143T	1	128	28	15	5	10		
116	27	15	5	10	133	29	15	5	10	145T	1 1/2-2	133	29	15	5	10		
126	28	15	5	10	143	30	15	5	10	182T	3	143	30	15	5	10		
133	29	15	5	10	148	31	15	5	10	184T	5	148	31	15	5	10		
195	31	16	6	12	214	33	16	5	12	213T	7 1/2	214	33	16	5	12		
219	33	16	5	12	234	35	16	5	12	215T	10	234	35	16	5	12		
332	26	18	5	13	347	38	18	5	13	254T	15	346	38	18	5	13		
357	38	18	5	13	381	40	18	5	13	256T	20	381	40	18	5	13		
6RA	G6, H6, J6, K6				NEMA Motor Frame	1750 R.P.M. H.P.	6RTL	D6T, E6T, F6T				NEMA Motor Frame	1750 R.P.M. H.P.	6RATL	G6T, H6T, J6T, K6T			
	Disch. 2 1/2		Suct. 3					Disch. 2		Suct. 2 1/2					Disch. 2 1/2		Suct. 3	
Unit Wgt.	A	B	C	D	Unit Wgt.	A	B	C	D	Unit Wgt.	A	B	C	D				
245	35	18	6 1/2	12	182T	3	264	35	17	6 1/2	12	325	38	17	7	15		
249	36	18	6 1/2	12	184T	5	369	36	17	6 1/2	12	330	39	17	7	15		
341	38	19	6 1/2	13	213T	7 1/2	361	38	18	6 1/2	13	390	41	17	7	15		
361	40	19	6 1/2	13	215T	10	381	40	18	6 1/2	13	410	43	17	7	15		
436	43	19	6 1/2	13	254T	15	456	43	18	6 1/2	13	490	46	17	7	15		
475	45	18	6 1/2	15	256T	20	495	45	17	6 1/2	15	515	48	17	7	15		
545	46	19	6 1/2	15	284T	25	565	46	18	6 1/2	15	585	49	18	7	15		
575	48	19	6 1/2	15	286T	30	595	47	18	6 1/2	15	649	50	19	7	18		

Engineering Specifications

The contractor shall furnish (and install as shown on the plans) an Apco regenerative turbine type pump model.....size.....(Bronze Fitted) (Bronze Ring) (All Iron) (All Bronze). Each pump shall have a capacity of..... G.P.M. when operating at a total head of.....feet at the specified temperature, viscosity, specific gravity, and NPSH. The speed of the pump shall not exceed 1750 R.P.M. (Models A35, A4, B4, C4 and D4 can also be operated at 3500 R.P.M.) The pump is to be furnished with (mechanical seals) (packing). The pump shall be of vertically split case design with removable bearing housings and the channel rings shall be replaceable without replacing the bearing housings. The suction and discharge connections shall be cast integral with the casing. The discharge shall be in a vertical position and the pump shall be self-venting. The casing and bearing housings shall be cast of 30,000 pound tensile strength cast iron. The impeller(s) shall be located on the stainless steel shaft between grease lubricated ball bearings. The impeller shall be hydraulically self-centering and no external adjustment shall be necessary. Each pump shall be tested prior to shipment. The pump shall be mounted on a (steel drip rim) (steel) baseplate and flexibly coupled to a.....HP.....phase..... hertz.....voltage..... R.P.M., horizontal (dripproof) (totally enclosed) (explosion proof) motor. The motor shall be sized to prevent overloading at the highest head condition listed in the specifications.

MAXIMUM DIFFERENTIAL PRESSURE – P.S.I.		
PUMP SIZES	R4	90
	J6, K6	100
	P4	110
	I4A, M4, I4TA, P5, H6	125
	I4, I4T, H5, I5, M5, N5, G6	150
	L5	175
	A35, A4, B4, C4, D4, E4, F4, G4, H4, G4T	200
	K5	220
	G5	225
	J5	230
	F4T, D5, E5, F5, H5T, I5T, J6T, K6T	250
	D4T, E4T, D5T, E5T, F5T, G5T, D6T, E6T, F6T, G6T, H6T	300

NOTE: Maximum differential pressure based on allowable shaft deflection for standard shafts.

MAXIMUM HORSEPOWER	
E4, F4, G4, H4, I4, I4A, D4T, E4T, F4T, G4T, I4T, I4TA	4
A35, A4, B4, C4, D4	7-1/2
M4, P4, R4, D5, E5, F5, G5, H5, I5, D5T, E5T, F5T, G5T, H5T, I5T	10
J5, K5, L5, M5, N5, P5	20
G6, H6, J6, K6, D6T, E6T, F6T, G6T, H6T, J6T, K6T	40

Description	Material of Construction
Retainer	Nylon
Bearing Covers	Cast Iron — ASTM A48
Casing	Cast Iron — ASTM A48
Channel Rings	Cast Iron — ASTM A48
Glands	Cast Iron — ASTM A48
Impellers	Bronze — ASTM B62
Packing	Graphited Teflon Fiber
Shaft	Stainless Steel — AISI 416

Limitations

- Max. hydrostatic test pressure 450 P.S.I.
except G6-H6-J6-K6 265 P.S.I.
- Max. case working pressure 300 P.S.I.
except G6-H6-J6-K6 175 P.S.I.
- Max. suction pressure 175 P.S.I.
except two stage 116 SERIES
with optional 250 lb. suction flange 300 P.S.I.
- Max. recommended packing box pressure 100 P.S.I.
- Max. recommended mechanical seal chamber pressure 250 P.S.I.
except 114A, 4R, 4RTL 150 P.S.I.
- Box or seal chamber pressure equals – single stage:
suction pressure plus 60% differential pressure. Two stage: 1st stage
equals – suction pressure plus 30% differential, 2nd stage equals –
suction pressure plus 80% differential.
- Max. temperatures
 - *Packing 275° F
 - Std. mechanical seal 225° F
 - Hi-temp mechanical seal 275° F
 - *Packing.....Suction lift requires lantern ring, 115 and 116 Series only.

NOTE: Aurora Pump reserves the right to make revisions to its products and their specifications, and to this bulletin and related information without notice.

— Your Authorized Local Distributor —



MARKETING & SALES:
800 AIRPORT ROAD • NORTH AURORA, ILLINOIS U.S.A. • 60542
PHONE: (630) 859-7000 U.S.A./CANADA FAX: (630) 859-7060
WORLDWIDE FAX: (630) 859-1226

AURORA MFG. PLANT:
800 AIRPORT ROAD • NORTH AURORA, ILLINOIS U.S.A. • 60542

SALES OFFICES IN ALL MAJOR CITIES AND COUNTRIES
Refer to "Pumps" in yellow pages of your phone directory
for your local Distributor

